

# EV512A-45

## DATA SHEET



### EV Traction Dry Cell Industrial Battery Block

Discover® EV Series Industrial Batteries provide superior high integrity and reliability for commercial, industrial and private applications. The maintenance-free, thick plate construction, designed for tough applications and repeated deep discharging makes the EV Series the definitive choice for robust Traction applications including Home Medical Equipment (HME), Electric Vehicle, Automated Guided Vehicles (AGV), Aerial Lifts, Floor Cleaning Equipment, Robotics, Materials Handling, Renewable Energy and Marine / RV applications.

#### Mechanical Drawings

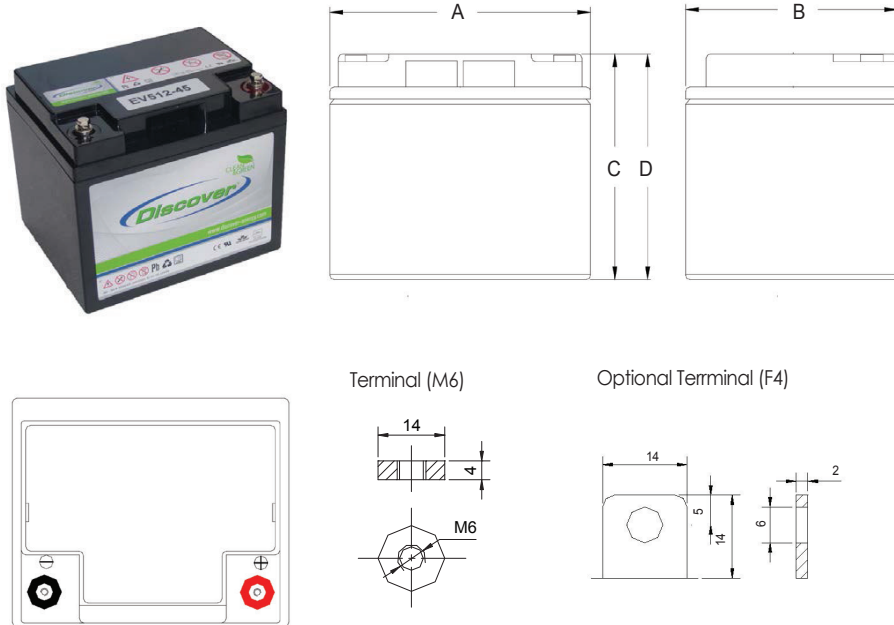

#### Mechanical Specifications

Industry Reference	-	
Length (A)	7.8 in	197 mm
Width (B)	6.5 in	165 mm
Height (C)	6.5 in	165 mm
Total Height (D)	6.7 in	170 mm
Weight	30 lbs	14 kgs
Terminal (Opt'l)*	M6 (F4)	
Cells	6	
Electrolyte	1.2875 S.G.	AGM

\*TERMINAL TORQUE: Please refer to our document, located in the Resources webpage ([www.discover-energy.com/resources/](http://www.discover-energy.com/resources/)).

#### Electrical Specifications

Volts	12 V	
80% DOD Voltage Cutoff	11.4 V	
RINT	7.80 mΩ	
Short Circuit (-68°F   20°C)	1430 A	
Self Discharge	<3% of capacity month @ 20°C (68°F)	
Cranking Amps**	370 @ 0°C (32°F)	310 @ -18°C (0°F)
Charging	-10°C (-4°F)   50°C (122°F)	
Discharge	-20°C (-4°F)   50°C (122°F)	
Storage	40°C (-40°F)   60°C (140°F)	

\*\*CRANKING AMPS: Cranking Amps data is provided as a reference only. Specific application sizing and life factors must be considered when using deep cycle product in a starting application.

#### Electrical Specifications

Amp Hours (AH)						Minutes of Discharge				
100 HR	20 HR	10 HR	5 HR	3 HR	1 HR	@25A	@56A	@75A	@85A	@100A
54	50	45	40	35	29	75	27	18	15	12

Max Charge   Discharge Currents	Peak (5 seconds)	Peak (10 seconds)	Max Continuous	Recommended Max Continuous
Charge	1C10Hr	0.75C10Hr	0.5C10Hr	0.3C10Hr
Discharge	2C10Hr	1.5C10Hr	1C10Hr	0.5C10Hr

#### Benefits & Features

Maintenance-Free Clean & Green® choice of Original Equipment Manufacturers.

Traction heavy duty grid design (PbCaSn) gives consistent active material adhesion and corrosion resistance.

High impact reinforced copolymer and polypropylene cases with flat top designs.

A recognized gas recombination efficiency of greater than 99.9%.

Multiple terminal, configuration options and carrying handles available with most models.

Classified as a non-spillable battery and is not restricted for transportation by:

- Air (IATA/ICAO provision 67)
- Surface (DOT-CFR-HMR49)
- Water (per IMDG amendment 27)

Compatible with sensitive electronic equipment.

Comprehensive design to conserve resources, improve safety and reduce waste. 98% recyclable.

#### Certified Quality

Designed in accordance with and published in compliance with applicable BCI, IEC and BS EN standards, including:

- IEC60896-21/22
- BS EN 60254-1:2005
- AS/NZS 4029.2:2000 BS EN 60254-1:2005 (MOD)

Discover® and its facilities and products are certified to multiple standards:

- ISO, UL, QS, and TUV standards
- ETIS Germany
- Euro Bat classification for Environmental Stewardship Standards



#### Contact Us



Unit 5-13511 Crestwood Place,  
Richmond, BC, V6V 2E9, Canada  
Email: [info@discover-energy.com](mailto:info@discover-energy.com)  
[www.discover-energy.com](http://www.discover-energy.com)

### Constant Current IUI Pulse Termination

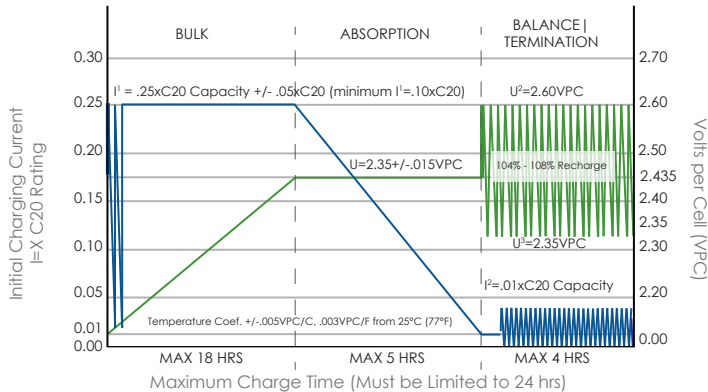

**NOTE:** This algorithm uses a pulse termination criterion. As a safety precaution during the Finish phase, if the average cell voltage, or volts per cell (vpc), exceeds V2 and the charger output has been on for more than 30 seconds, the output is shut off until the vpc falls to V3. The finish phase then resumes and this "pulsing" continues until the target overcharge (108% - 112%) is reached.

### Constant Current IUI

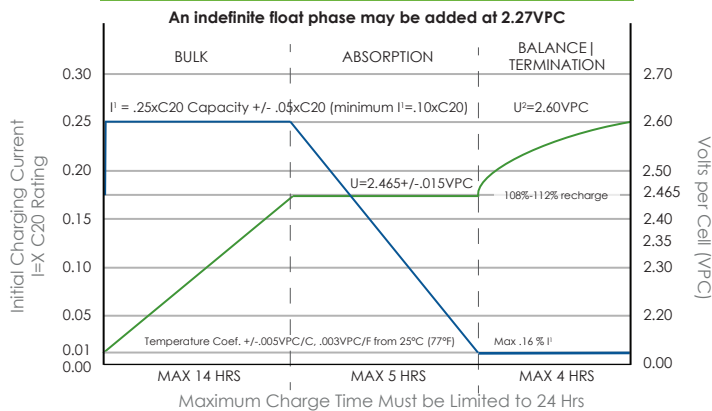

### Voltage Regulated IUI

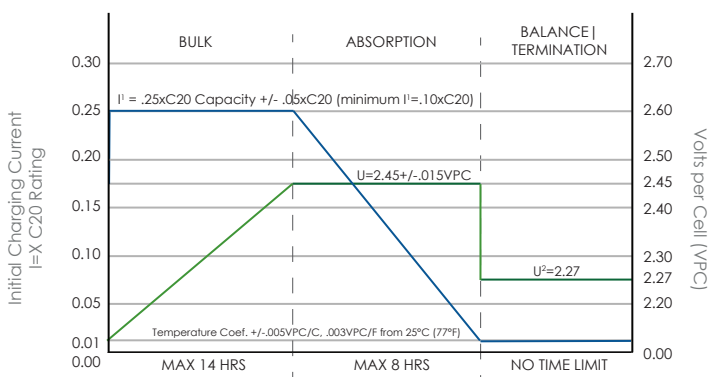

### Cycle Service Life in Relation to Depth Discharge

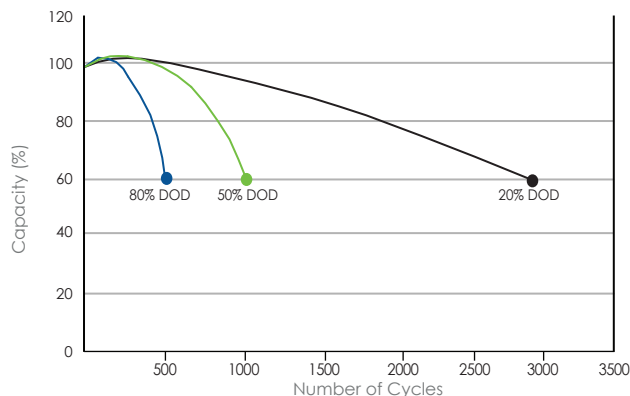

### Relationship of OCV and SOC 20°C

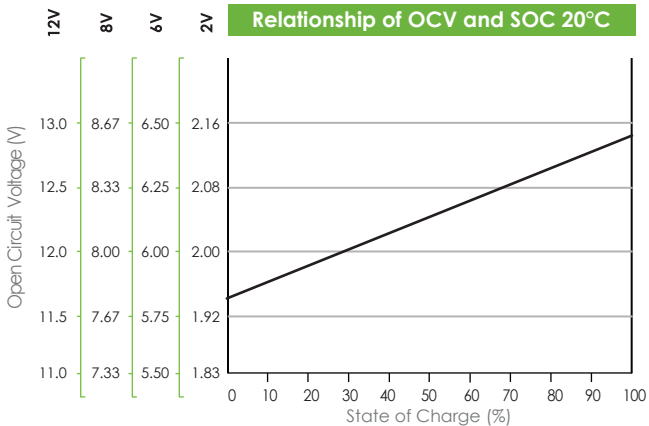

### Self-Discharge Characteristics

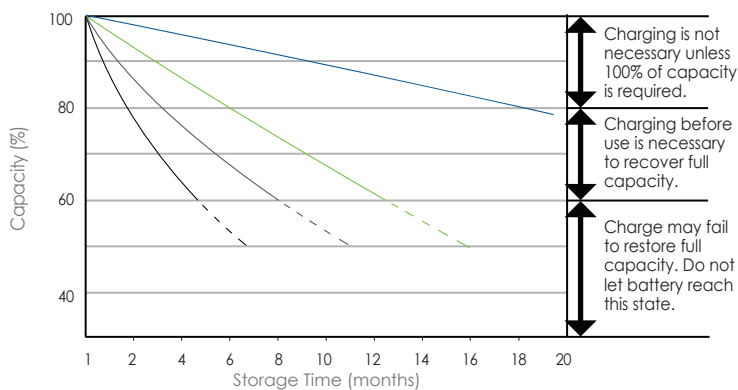

### Relationship between Charging Voltage and Temperature

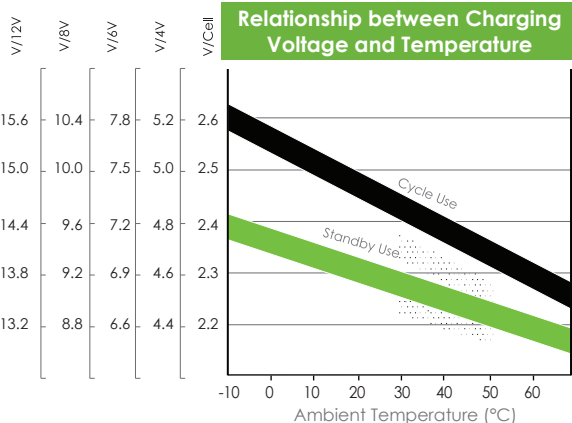

### Temperature Effects on Capacity

