

# 2VRE-1100TG

DATA SHEET



## Tubular Gel OPzV Battery Cell

Discover® Tubular Gel RE Batteries provide superior deep cycling performance and reliability for demanding commercial, industrial and residential applications. Discover® Tubular Gel RE Batteries utilize Advanced Tubular Plate Technology to deliver long service life with maintenance-free requirements. Gel RE Batteries provide reliable energy storage for Stationary Backup and Telecom Networks, Road Surface, and Rail Traffic Signaling Systems, Solar, Wind, and Hybrid Off-grid and Grid-Tie renewable energy applications. Discover® Tubular Gel RE Batteries provide maximum efficiency per discharge-charge cycle, and proven reliability in remote, high temperature, or unstable power network installations.

### Mechanical Drawings

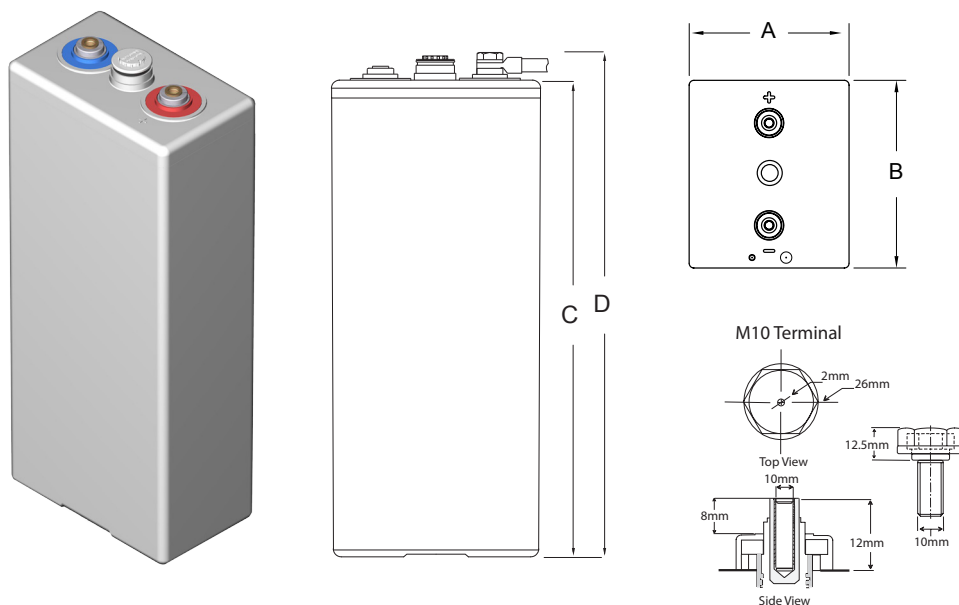

### Mechanical Specifications

Industry Reference	2V Tubular Gel OPzV	
Length (A)	4.9 in	124 mm
Width (B)	8.1 in	206 mm
Height (C)	18.5 in	471 mm
Total Height (D)	19.6 in	498 mm
Weight (Wet)	68 lbs	31 kgs
Terminal	M10 Insert	
Poles	2	
Cell(s)	1	
Container	ABS	

### Electrical Specifications

Reference LVD (I10 at 20°C   68°F)	20% DOD	2.0V
	50% DOD	1.95V
	80% DOD	1.9V
Cycle Life	20% DOD	7000
	50% DOD	2950
	80% DOD	1900
RINT	0.6 mΩ	
Short Circuit (20°C   68°F)	3380 A	
Self Discharge (20°C   68°F)	2-3% per month	
Maximum Operating Temperature	-20°C   -4°F - 45°C   113°F	
Electrolyte (20°C   68°F)	1.26 S.G.	

### Electrical Specifications

1.85 VPC at 20°C   68°F				1.75 VPC at 27°C   80°F				1.75 VPC at 20°C   68°F			
240 HR	120 HR	120 HR	100 HR	20 HR	10 HR	8 HR	5 HR	3 HR	1 HR	1 HR	1 HR
567 AH	1.13 KWH	564 AH	556 AH	446 AH	405 AH	-	365 AH	320 AH	0.4 KWH	212 AH	

### Constant Power Reference in Watts / Cell to 1.92VPC at 20°C | 68°F

240 HR	168 HR	120 HR	100 HR	72 HR	50 HR	48 HR	24 HR	20 HR	12 HR	10 HR
4.1	5.7	7.8	9.1	12.2	16.6	17.2	30.4	35.2	52.5	60.3

### Benefits & Features

#### Unparalleled Performance

- Engineered to deliver 80% of rated capacity above 1.9 volts.

#### Long Cycle Life

- Tubular positive plates and proprietary alloy compositions to provide a 50% Depth of Discharge cycle life of up to 2950 cycles @ 20°C | 68°F.

#### Low Total Cost of Ownership

- Low cost per cycle. Lifetime value maximized especially in hybrid systems where using batteries can dramatically reduce generator run times delivering lower maintenance and fuel costs and less CO2 emissions.

#### Maintenance-Free

- Sealed technology, Gel electrolyte and safety pressure relief valve with integral flame arrestor.

#### Complete Battery Solution

- Complete and ready to install systems with all necessary installation accessories. Flame retardant (UL 94-V0) containers available upon request.

#### Safe

- Tested and verified for compliance to applicable International Safety Standards.

#### IEC 61427 Compliant

- Tested for compliance with the International Electrical Commission requirements for battery performance and life in PV applications.

### Certified Quality

Discover Energy Corp. and its facilities and products are certified to multiple standards and compliance:

- IEC 60896-21: Requirements for Photovoltaic Energy
- IEC 60896-22: Requirements for Valve-Regulated lead-acid batteries
- DIN 40742: Specifications for Tubular Gel RE Cells
- DIN 40744: Specifications for Tubular Gel RE Blocks
- EN 50272-2: Safety Requirements for stationary batteries
- ISO 9001, ISO 14001, BS OHSAS 18001: Manufacturing and Production facilities.
- ETTS Germany



### Contact Us



Unit 4&5-13511 Crestwood Place,  
Richmond, BC, V6V 2E9, Canada  
Email: info@discover-energy.com  
www.discover-energy.com



**Expected Number of Cycles vs. DOD**

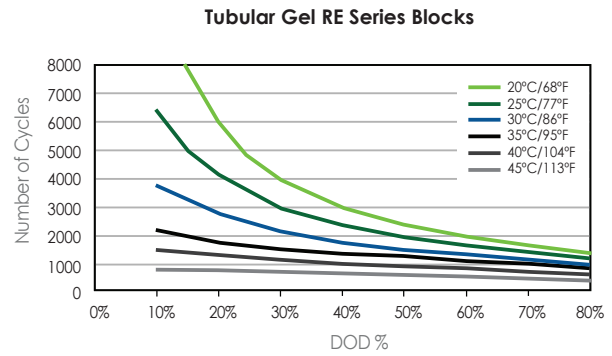
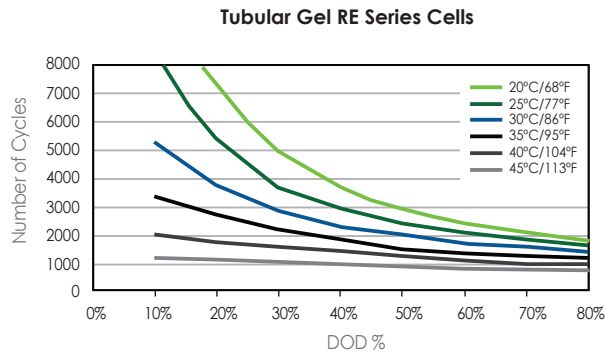

**Self-Discharge Characteristics**

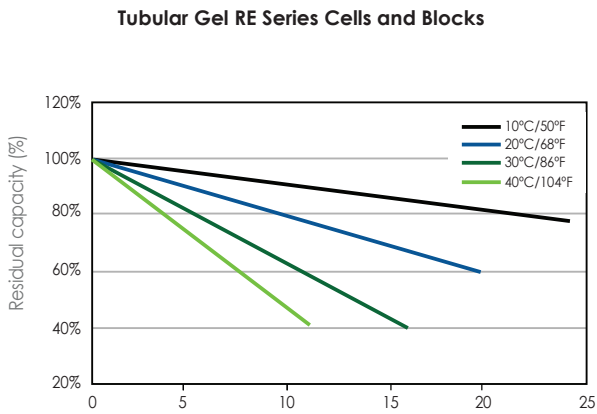

**Capacity vs. Temperature**

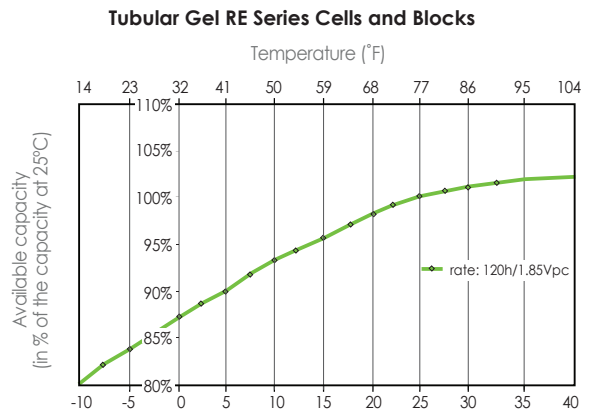

**Guidance for the Initial Low-voltage Settings (25°C/77°F Reference Temperature)**

